

HVH250-090 Electric Motor

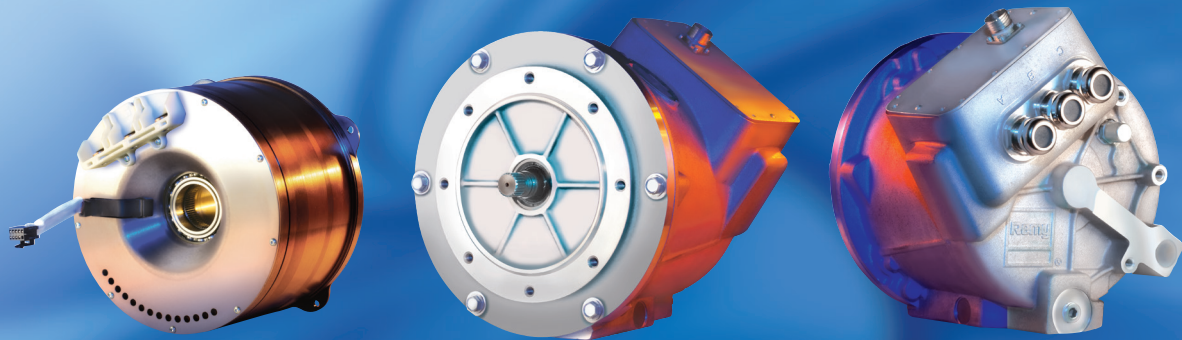

Product Sheet

The HVH250 Series motors come in various stack length, cooling and winding configurations.

They are available as fully housed motors or as rotor/stator assemblies. The HVH250 is a powerful, durable and rugged electric motor/generator for use in on- and off-highway vehicles, power generation and other special high power demand applications.

With billions of kilometers of proven reliability, the HVH motors are supported by the largest independent electric motor test and R&D facility in North America.

Features & Benefits

- Peak efficiencies > 95%
- Designed with 120 years of automotive experience for ultimate reliability
- World class power density
- More than 10 years of continuous production and more than 100,000 motors in service
- Global sales and tech support
- Production capacity of up to 80,000 HVH motors per year

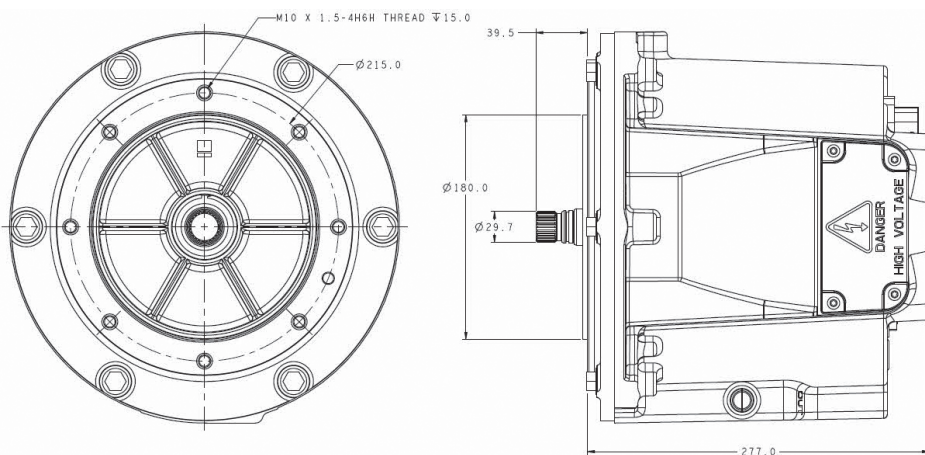

HVH250-090 Electric Motor

Product Details

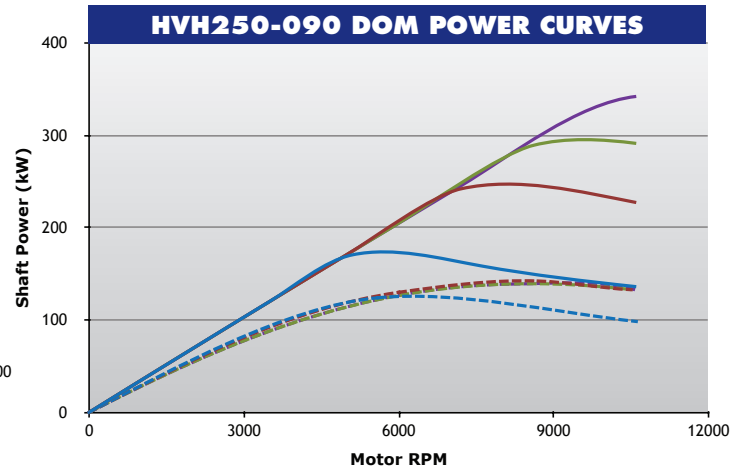
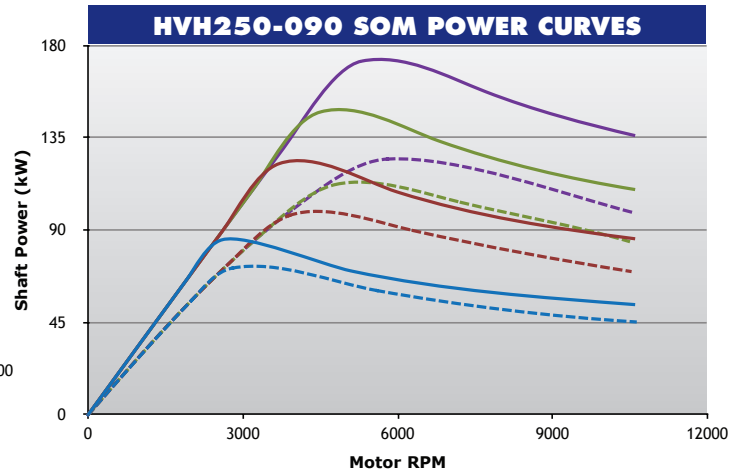
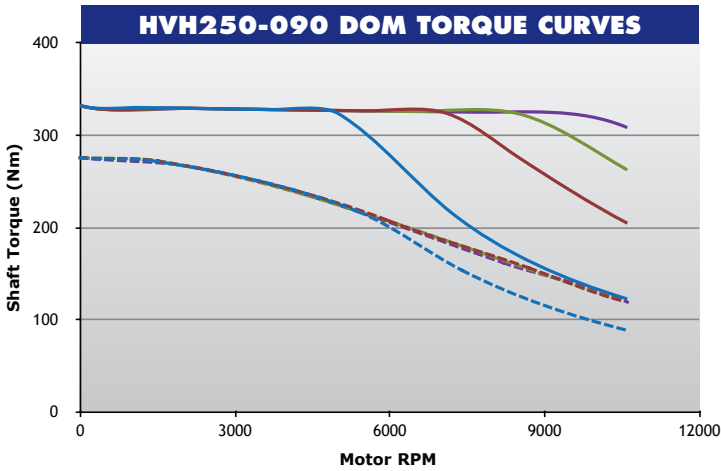
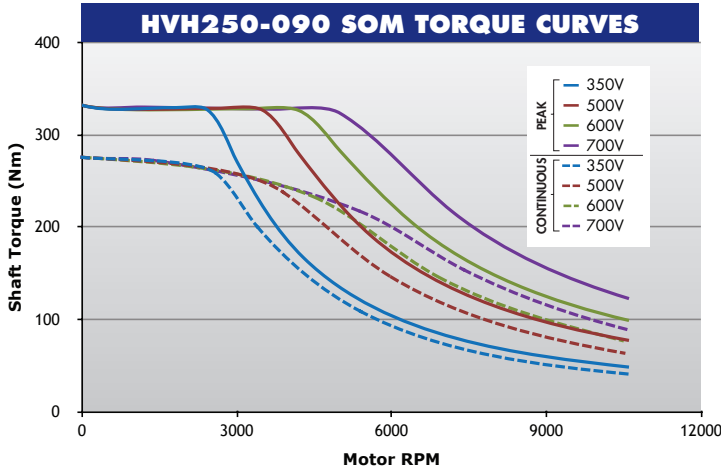

TYPICAL REPRESENTATIVE EFFICIENCY PLOT

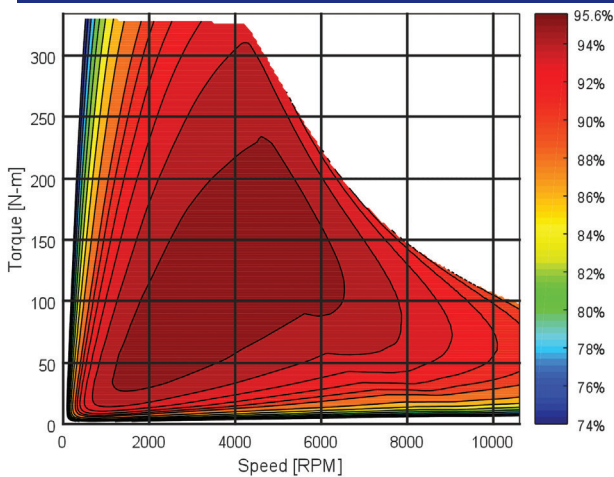

OPERATING CONDITIONS

Typical Coolant Inlet Temperature	up to 90 C
Typical Coolant Flow Rate	5 to 30 LPM
DC Bus Voltage	up to 700 V
Peak Current	300*/600** Arms
Rated Peak Operating Time	60 sec
Standard Cooling Medium	Dexron VI

MOTOR MASS DATA

Motor Assembly	49 kg
Motor Rotational Inertia	0.067 kg-m ²

*Series wound stator **Dual path stator

Note: Graphs above are based on actual test data. The torque and power ratings are based on typical operating conditions as noted on the performance graphs. There are several variables that may change the motor performance, including coolant flow rate, operating temperature, inverter settings and parameters, etc. For actual performance, the motor must be evaluated in its final system and application. All specifications are subject to change.